

## Installation instructions

**i** Refer to installation use and maintenance manual for more information.



## Controller bipolar integrated drive for 2 phase step motor

- DC power Supply: 12 ± 48 Vdc
- DC Logic Supply: 24Vdc (mandatory but NOT isolated)
- Phase current: up to 6,0 Arms (8.5 Apk)
- Chopper frequency: ultrasonic 40 kHz
- Stepless Control Technology (65536 position per turn)
- Service SCL interface for programming and real time debugging
- Protections: over-current, over-temperature, short circuit phase-phase motor and phase-ground
- Modbus RTU or Canbus or EtherCAT or Modbus TCP/IP (Ethernet) or Profinet communication interfaces
- 4 Digital inputs not isolated
- 2 Digital outputs not isolated (supplied from 24Vdc logic supply)
- 1 Analog input not isolated
- Dimensions: (refer to picture)
- IP protection: IP65
- Working temperature 5°C + 40°C; Storage temperature -25°C + 55°C
- Humidity : 5% + 85% not condensing



## Mechanical data and models

**i** Handle systems with care by taking them from the motor side and not from the electronics side.

Shaft axial load = 15 N max  
Shaft radial load = 75 N max (on front shaft end)

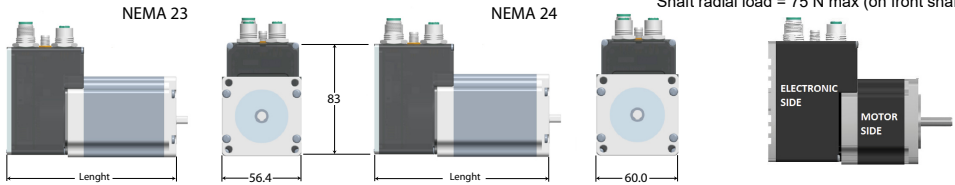

Composition code	SM4D	2	60P	x	2	7	k	z	w	0
<b>Model</b> ( Fieldbus type = x letter )	<b>Fieldbus type</b>									
SM4D260P <b>C</b> 275kzw0	Canbus									
SM4D260P <b>M</b> 275kzw0	Modbus RTU									
SM4D260P <b>H</b> 275kzw0	EtherCAT									
SM4D260P <b>E</b> 275kzw0	Modbus TCP/IP (Ethernet)									
SM4D260P <b>T</b> 275kzw0	Profinet									
<b>Model</b> ( Motor NEMA 23 = letter k ) ( Motor size = letter z )	<b>Length (mm)</b>	<b>Shaft Ø (mm)</b>	<b>Holding Torque (Nm)</b>	<b>Rotor Inertia (g.cm<sup>2</sup>)</b>						
SM4D260P <b>x275A</b> w0	96.0	6.35	0.5	170						
SM4D260P <b>x275B</b> w0	107.0	6.35	1.2	280						
SM4D260P <b>x275C</b> w0	T.B.D.	6.35	T.B.D.	T.B.D.						
SM4D260P <b>x275D</b> w0	131.0	6.35	2.0	520						
SM4D260P <b>x275E</b> w0	T.B.D.	6.35	T.B.D.	T.B.D.						
<b>Model</b> ( Motor NEMA 24 = letter k ) ( Motor size = letter z )	<b>Length (mm)</b>	<b>Shaft Ø (mm)</b>	<b>Holding Torque (Nm)</b>	<b>Rotor Inertia (g.cm<sup>2</sup>)</b>						
SM4D260P <b>x272A</b> w0	T.B.D.	8.00	T.B.D.	T.B.D.						
SM4D260P <b>x272B</b> w0	T.B.D.	8.00	T.B.D.	T.B.D.						
SM4D260P <b>x272C</b> w0	T.B.D.	8.00	T.B.D.	T.B.D.						
SM4D260P <b>x272D</b> w0	137.5	8.00	3.0	920						
SM4D260P <b>x272E</b> w0	T.B.D.	8.00	T.B.D.	T.B.D.						
<b>Model</b> ( Feedback type = letter w )	<b>Encoder type</b>									
SM4D260P <b>x27kzN</b> 0	Without feedback									
SM4D260P <b>x27kzT</b> 0	Incremental encoder 4096ppr									
SM4D260P <b>x27kzM</b> 0	Incremental encoder 4096ppr + Absolute single turn									
SM4D260P <b>x27kzB</b> 0	Absolute multiturn encoder BISS-C									

# System connections

Connectors:

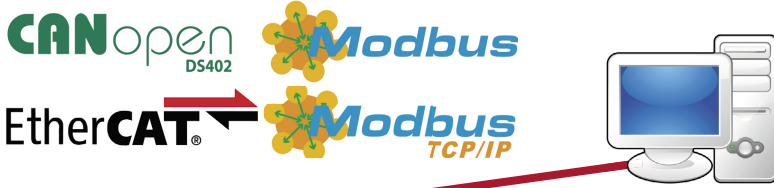

**CN3: Inputs and outputs**

**CN5B Communication interface**

**CN1: Power supply**

**CN5A Communication interface**

**CN6 Service SCI**

Composition code	SM4D	2	60P	x	2	7	k	z	w	0
------------------	------	---	-----	---	---	---	---	---	---	---

## CN1 Power supply







CN1.1	Vlog	PWR_IN	Positive DC input logic supply (24 Vdc) <b>(mandatory but NOT isolated)</b>	<b>Connector</b>  Type: M12 A-Code, 5 pins, Male Manufacturer: LTW Model: LTW M12A-05PMMC-SF8001
CN1.2	PGND	PWR_IN	Negative reference for power and logic supply <b>BOTH PINS MUST BE CONNECTED</b>	
CN1.3	PGND			
CN1.4	VIN	PWR_IN	Positive DC input power supply (12÷48 Vdc) <b>BOTH PINS MUST BE CONNECTED</b>	
CN1.5	VIN			

**Note: VIN and PGND are each available in two terminals. Make sure that both terminals are connected in order to split the supply current in two terminal and thereby avoid an overload of the connector.**

## CN3 Inputs and outputs

CN3.1	B0_IN0	DIG_IN	Digital input PNP positive side B0_IN0	<b>Connector</b>  Type: M12 A-Code, 8 pins, Female Manufacturer: LTW Model: LTW M12A-08PFFS-SF8001
CN3.2	B0_IN1	DIG_IN	Digital input PNP positive side B0_IN1	
CN3.3	B0_IN2	DIG_IN	Digital input PNP positive side B0_IN2	
CN3.4	B0_IN3	DIG_IN	Digital input PNP positive side B0_IN3	
CN3.5	B0_OUT0	DIG_OUT	PNP digital output OUT0	
CN3.6	B0_OUT1	DIG_OUT	PNP digital output OUT1	
CN3.7	GND	PWR_OUT	Negative reference of inputs and outputs	
CN3.8	IN_AN0	AN_IN	Analog input IN_AN0	

# System connections

Composition code	SM4D	2	60P	x	2	7	k	z	w	0
<b>CN5A/B: Communication interface</b>										
<b>x = "C" type - CANbus</b>				<b>Connector</b>						
CN5.1	n.c.	---	Not connected	 <p>Type: M12, A-Code, 5 pins, Female                      Manufacturer: LTW                      Model: LTW M12A-05PFFC-SF8001</p>						
CN5.2	n.c.	---	Not connected							
CN5.3	CAN_GND	PWR output	Signal ground							
CN5.4	CAN_H	Digital I/O	Bus Line High							
CN5.5	CAN_L	Digital I/O	Bus Line Low							
<b>x = "M" type - Modbus RS485</b>				 <p>Type: M12, A-Code, 5 pins, Female                      Manufacturer: LTW                      Model: LTW M12A-05PFFC-SF8001</p>						
CN5.1	n.c.	---	Not connected	 <p>Type: M12, A-Code, 5 pins, Female                      Manufacturer: LTW                      Model: LTW M12A-05PFFC-SF8001</p>						
CN5.2	n.c.	---	Not connected							
CN5.3	0V_A	PWR output	Signal ground							
CN5.4	Data +	Digital I/O	Not inverting signal RS485							
CN5.5	Data -	Digital I/O	Inverting signal RS485							
<b>x = "H" type - EtherCAT</b>				<b>Connector</b>						
CN5.1	TX+	DIG_OUT	Transmit Data +	 <p>Type: M12 D-Code, 4 pins, Female                      Manufacturer: LTW                      Model: LTW MSDS-04PFFC-SF8001</p>						
CN5.2	RX+	DIG_OUT	Receive Data +							
CN5.3	TX-	DIG_OUT	Transmit Data -							
CN5.4	RX-	DIG_OUT	Receive Data -							
Housing	Connected to PE									
<b>x = "E" type - Ethernet (only CN5A)</b>				<b>Connector</b>						
CN5A.1	TX+	DIG_OUT	Transmit Data +	 <p>Type: M12 D-Code, 4 pins, Female                      Manufacturer: LTW                      Model: LTW MSDS-04PFFC-SF8001</p>						
CN5A.2	RX+	DIG_IN	Receive Data +							
CN5A.3	TX-	DIG_OUT	Transmit Data -							
CN5A.4	RX-	DIG_IN	Receive Data -							
Housing	Connected to PE									
<b>x = "T" type - Profinet</b>				<b>Connector</b>						
CN5.1	TX+	DIG_OUT	Transmit Data +	 <p>Type: M12 D-Code, 4 pins, Female                      Manufacturer: LTW                      Model: LTW MSDS-04PFFC-SF8001</p>						
CN5.2	RX+	DIG_IN	Receive Data +							
CN5.3	TX-	DIG_OUT	Transmit Data -							
CN5.4	RX-	DIG_IN	Receive Data -							
Housing	Connected to PE									

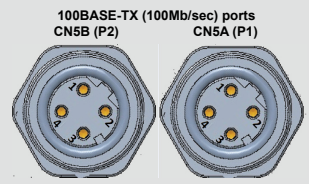
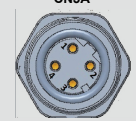
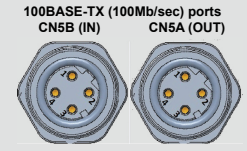
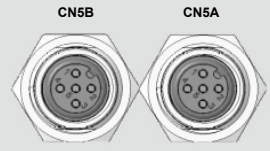

# System connections

## CN6 Service SCI interface

CN6.1	GND	PWR_OUT	GND power output
CN6.2	+5L	PWR_OUT	+5V power output
CN6.3	DE / RE	DIG_OUT	Drive enable negated / Receive enable
CN6.4	TX / RX	DIG_I/O	Transmit / Receive line

**Connector**  
Type: M8 A-Code, 4 pins, Male

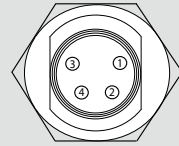

**i** This connection is possible **only** with hardware and software provided by EVER Co.  
Kit code: **SM4D\_SERV00-SL** or **SM4D\_SERV00-EE**

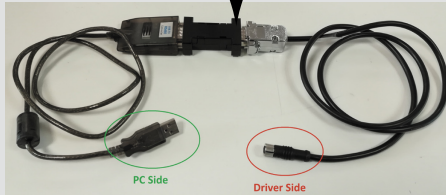

## Digital inputs (not isolated)

**i** 5-24 Vdc PNP type.

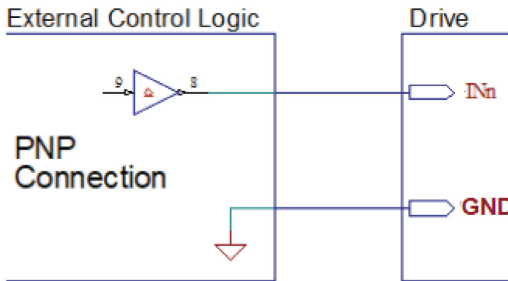

## Digital outputs (not isolated)

**!** **Digital outputs are supplied from the 24 Vdc of logic supply.**

**i** PNP type with  $V_{OUTmax} = 24Vdc$

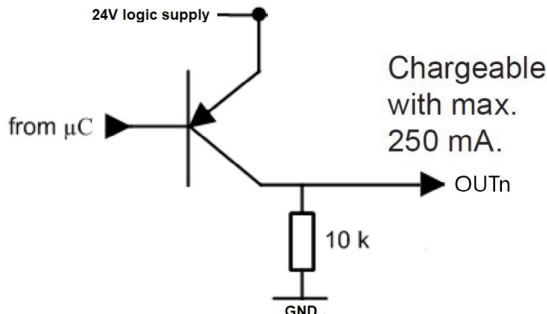

## Analog input (not isolated)

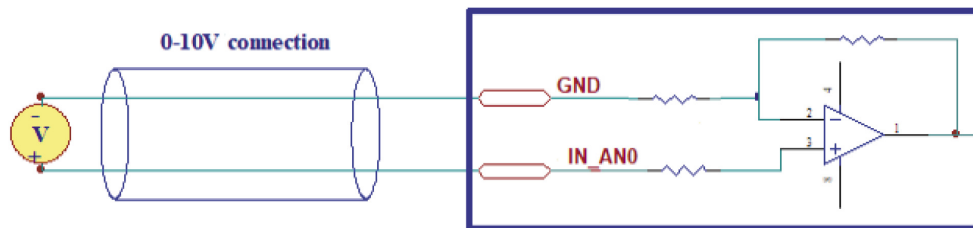

***GND is internally in common with PGND (power ground), this is potentially dangerous. Take all necessary measures to avoid possible contacts in the final installation.***

## Mating cable kit

Connection	Cable kits information	Kit order code
CN1	<p>Connector: M 12 A-Code 5 pins Female</p> <p>Pinout: 1 - Brown, 2 - White, 3 - Blue, 4 - Black, 5 - Green or Gray.</p> <p>Conductors: UL2517 AWG#22</p> <p>Cable: Black PVC Jacket</p> <p>Waterproof rate: IP68</p>	CA/LTW1205BF01 (1 mt. length)
CN3	<p>Connector: M12 A-Code 8 pins Male</p> <p>Pinout: 1 - White, 2 - Brown, 3 - Green, 4 - Yellow, 5 - Gray, 6 - Pink, 7- Blue, 8 - Red.</p> <p>Conductors: UL2517 AWG#24</p> <p>Cable: Black PVC Jacket</p> <p>Waterproof rate: IP68</p>	CA/LTW1208BM01 (1 mt. length)
CN5A/B Canbus or Modbus versions	<p>Connector: M12 A-Code 5 pins Male</p> <p>Pinout: 1 - Brown , 2 - White, 3 - Blue, 4 - Black, 5 - Green or Gray.</p> <p>Conductors: UL2517 AWG#22</p> <p>Cable: Black PVC Jacket (UV resistant)</p> <p>Waterproof rate: IP68</p>	CA/LTW1205BM01 (1 mt. length)
CN5A/B EtherCAT or Ethernet or Profinet versions	<p>Connector: M12 D-Code 4 pins Male Shielded</p> <p>Pinout: 1 - Brown, 2 - White, 3 - Blue, 4 - Black.</p> <p>Conductors: UL2517 AWG#22</p> <p>Cable: Black PVC Jacket</p> <p>Waterproof rate: IP68</p>	CA/LTW1204BMD01 (1 mt. length)

## Verify the installation

- Check all connection: power supply and inputs/outputs.
- Make sure all settings right for the application.
- Make sure the power supply is suitable for the drive.
- If possible, remove the load from the motor shaft to avoid that wrong movements cause damage.
- Enable the current to the motor and verify the applied torque.
- Enable a movement of some steps and verify if the rotation direction is the desired one.
- Disconnect the power supply, connect the load on the motor and check the full functionality.

## Analysis of malfunctions



*When one of the following situations occur, the drive doesn't function correctly and it is reported an error.*

DEFECT	CAUSE	ACTION
The external fuse to the drive burns.	May be due to a wrong connection of the power supply.	Adjust the connection and recover the fuse. Use a fuse suitable for the application.
Over temperature protection.	May be due to a duty cycle.	Increase the air flux and if it is possible chose a motor with higher torque at same current value.
Over current protection.	May be due to a short circuit on the motor power stage.	Shut down the power supply and check if the motor is damaged.
Noisy motor movement with vibrations.	May be caused due to a state of resonance.	Increase the resolution of the step angle and/or change the motor velocity to avoid resonance area.
The motor produce torque but doesn't rotate.	May be caused due to a wrong connection of the I/O's.	Check the connection of the I/O's.

### Ever Motion Solutions

Via del Commercio, 2/4 - 9/11  
Loc. San Grato Z. I  
26900 - L O D I - Italy  
Phone +39 0371 412318 - Fax +39 0371 412367  
email: infoever@everelettronica.it  
web: www.everelettronica.it

